

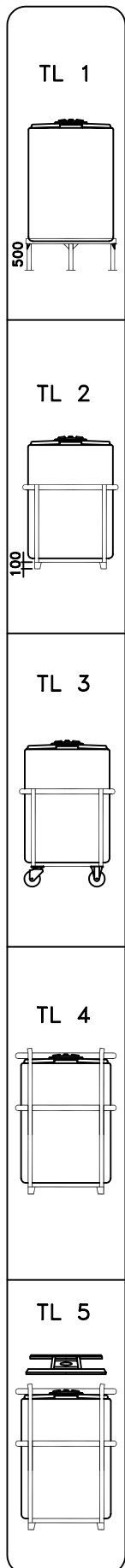

Lagertank 1.200 Liter, Typ LTV-1200



- 3 
- 2 
- 1  $\varnothing 285$
- 1: Behälteröffnung
2: Schraubdeckel CPM-300
3: Lüfter SF1

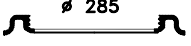
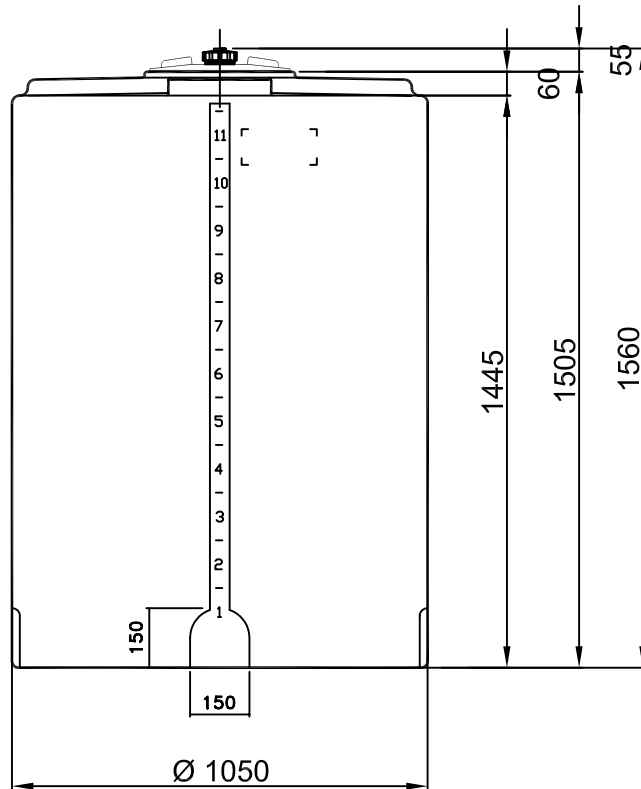

▲
Skala

*
Flachstellen

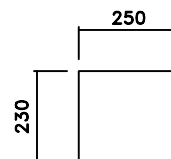
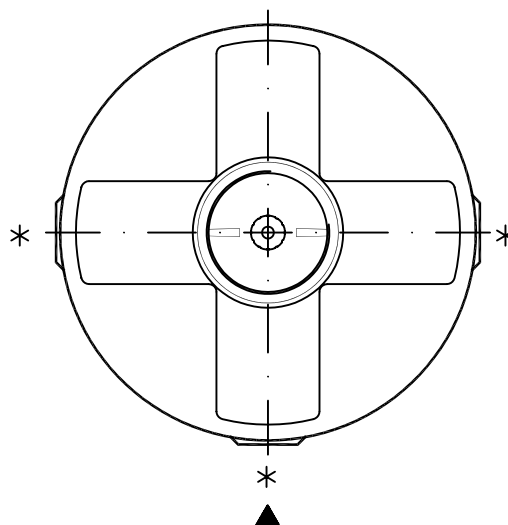

Montageflächen