

Lagertank 5.500 Liter, Typ LTV-5500

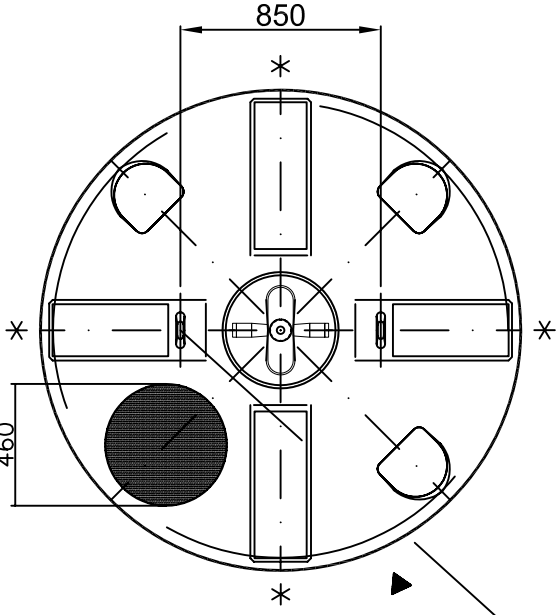
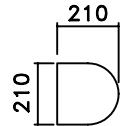
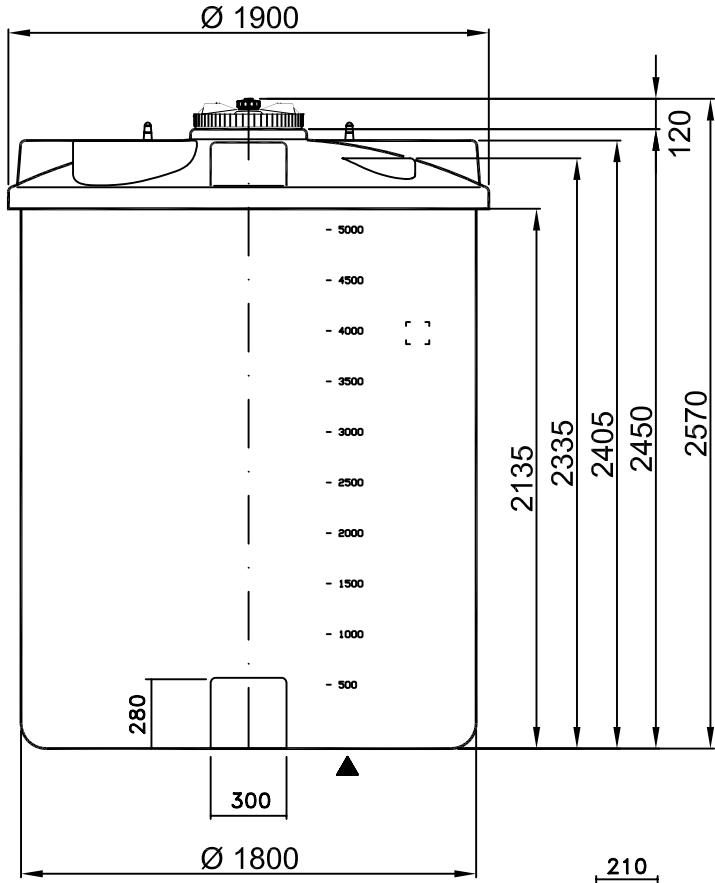
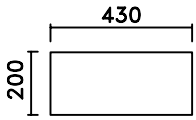
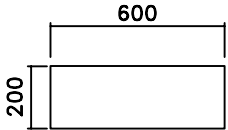
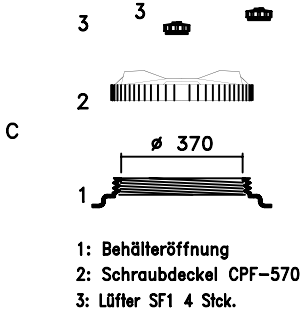
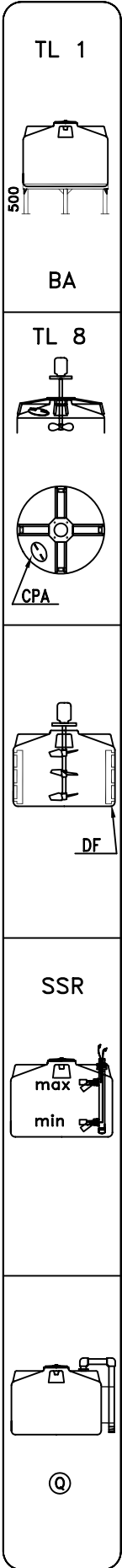

▲ Skala

* Flachstellen

▲ Kranösen
Ø 25