



Container 180 Liter, Typ TC 1/L

Löffel

Ø 155

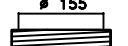

CPF-200

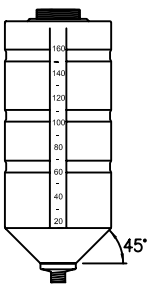

Innenbehälter

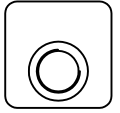

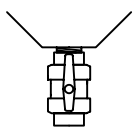

Entleerung

Vertikal

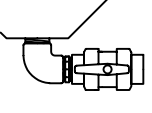
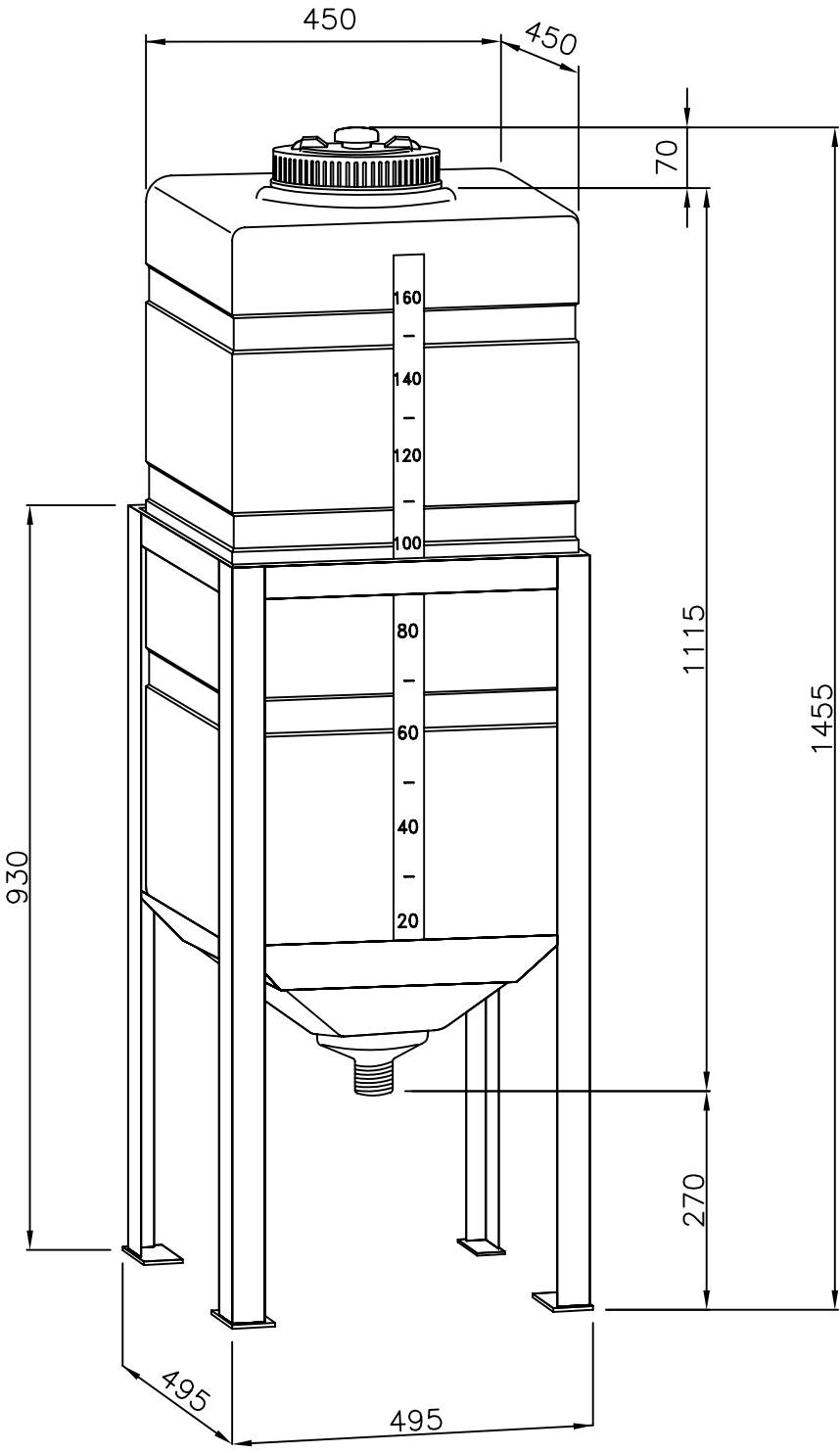

Horizontal

 = 1" - 1¼" - 1½" - 2" - 2½" - 3" - 4"