

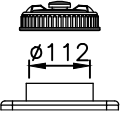
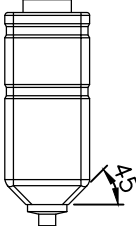

## Container 50 Liter, Typ TC 05/L

CPF 200

Innenbehälter
Entleerung

Vertikal

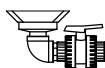
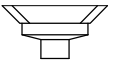
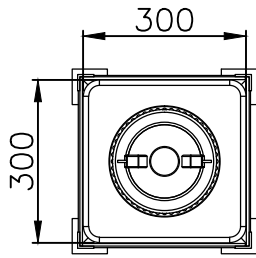
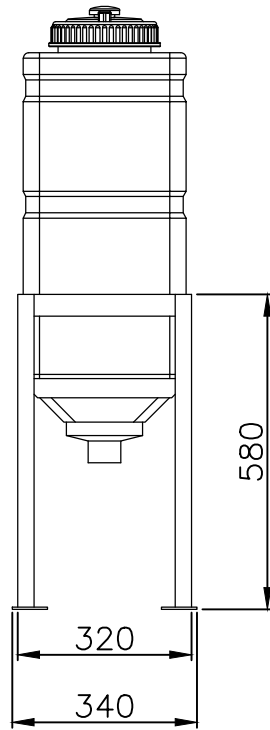
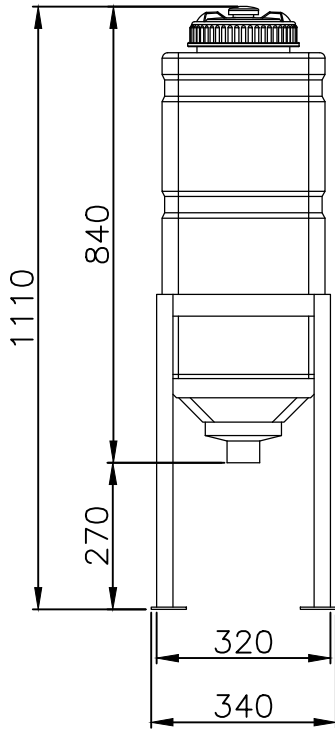
Horizontal



Entleerung: 1"-1¼"-1½"-2"-2½"-3"-4"

