

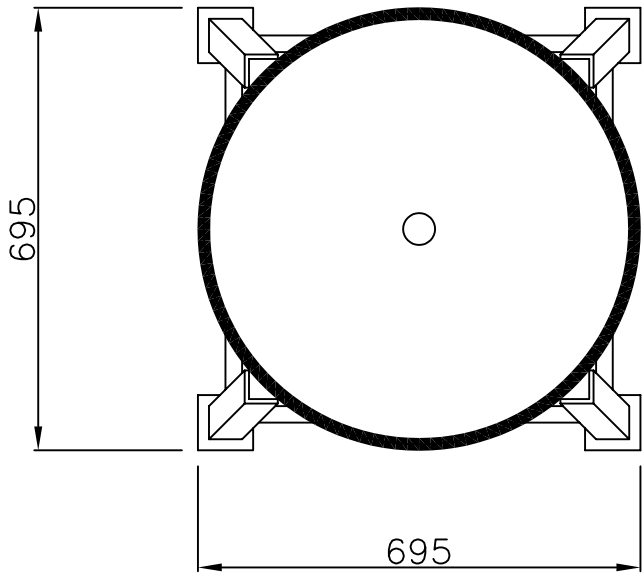

## Container 300 Liter, Typ TCO 3/L

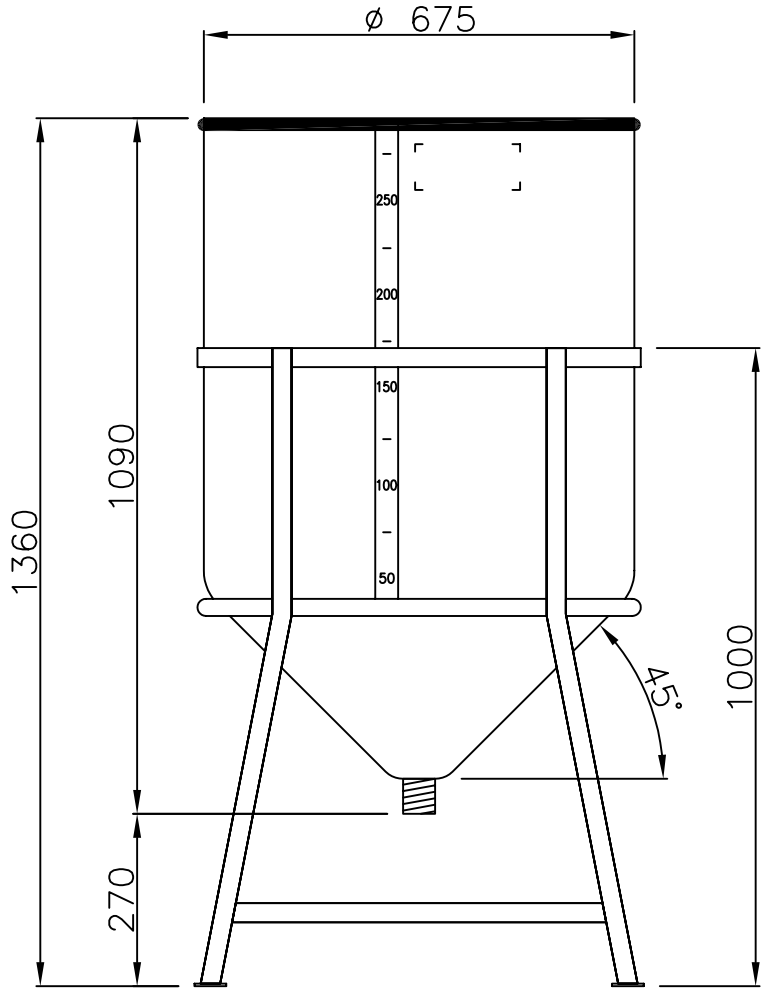

 = 1" - 1¼" - 1½" - 2" - 2½" - 3" - 4"