

Container 1.300 Liter, Typ TB 14/L

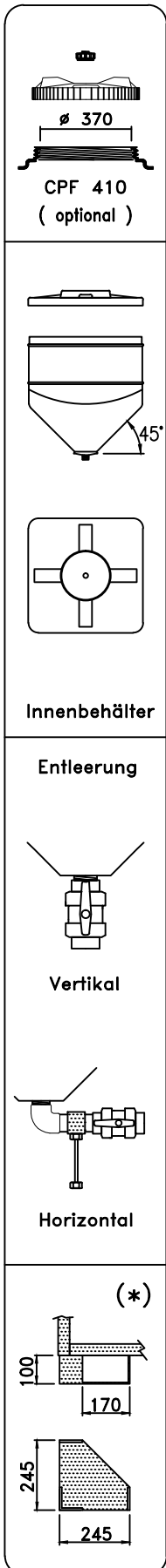

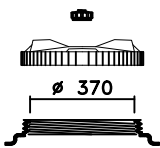

 CPF 410
 (optional)

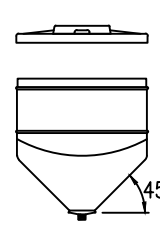

 Innenbehälter

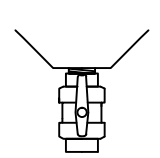

 Entleerung
 Vertikal

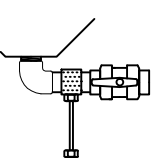

 Horizontal

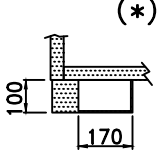

 (*)

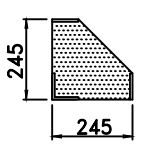

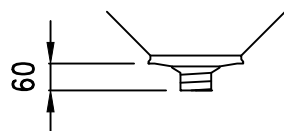
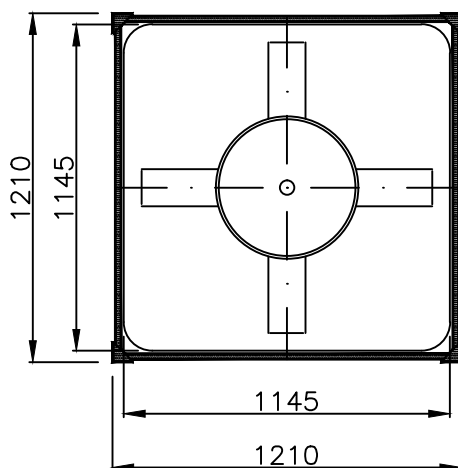
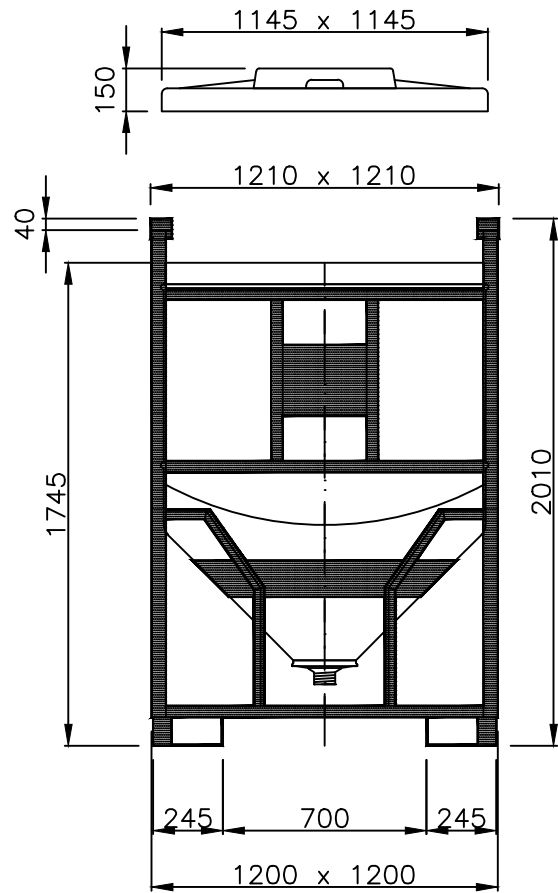
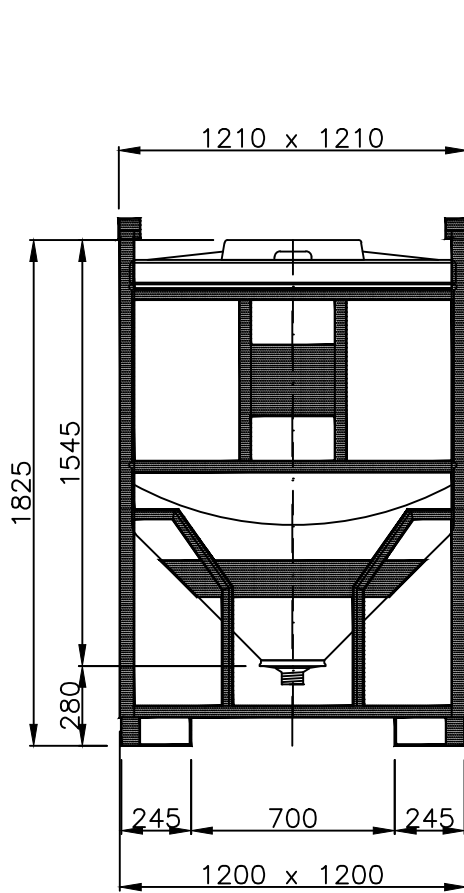

Entleerung : \varnothing 1" - 1¼" - 1½" - 2" Containerhöhe = 1900 mm
 Entleerung \varnothing 2½" - 3" - 4" Containerhöhe = 2095 mm